







28 508 360



- 200mm projection
- ball-joint pivotable through 30°
- Three settings: PURIFY RAIN, COMPACT SOFT FLOW, COMPACT AQUAPRESSURE FLOW, max. flow rate 7.6 l/min (at 3 bar)
- with anti-scale system
- spray head Ø 94mm
- rosette Ø 55 mm
- 1/2" connection
- This product reduces water consumption by % (compared to requirements of EPAAct '92)
- This product can contribute to Water Use Reduction in LEED® Green Building Rating
- This product can help a building meet the requirements of Green Building Rating Systems, e.g. LEED®, BREEAM®, DGNB

	Chrome	28 508 360-00 0010
	Brushed Platinum	28 508 360-06 0010
	Platinum	28 508 360-08 0010
	Durabrand (23kt Gold)	28 508 360-09 0010
	Brushed Durabrand (23kt Gold)	28 508 360-28 0010
	Brushed Dark Platinum	28 508 360-99 0010

28 508 360

mm [inches]



Flow rate chart

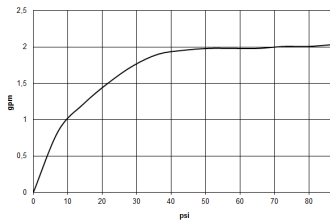

Certificates

LGA_38653.

28 508 360

Parts for other finishes can be found here: [Brushed](#)
[Platinum](#)

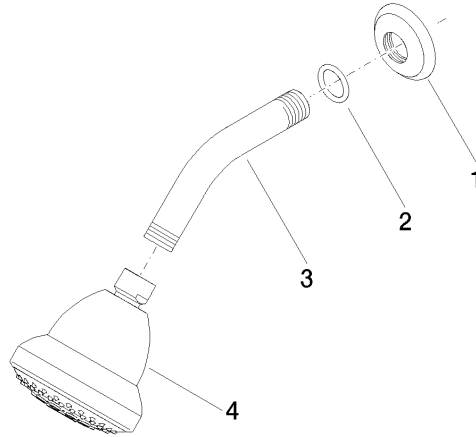

Spare parts list

No.	Item Number	Name	Quantity used	Delivery time
1	09 27 35 003-00	rosette	1	10
2	90 14 10 026 00 90	seal	1	2
3	09 11 03 011-00	connection	1	10
4	04 12 11 120 01-00	shower	1	10